

Example 04

1

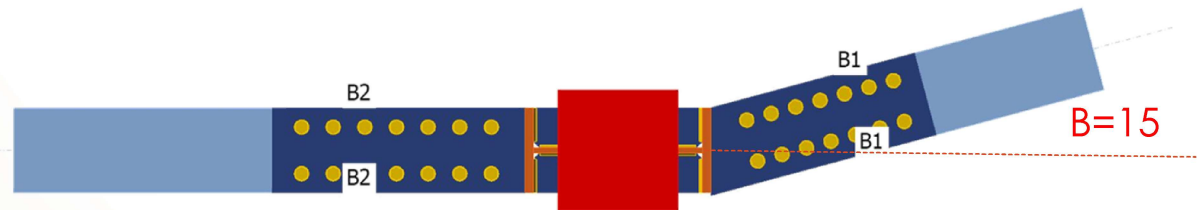

Example 04

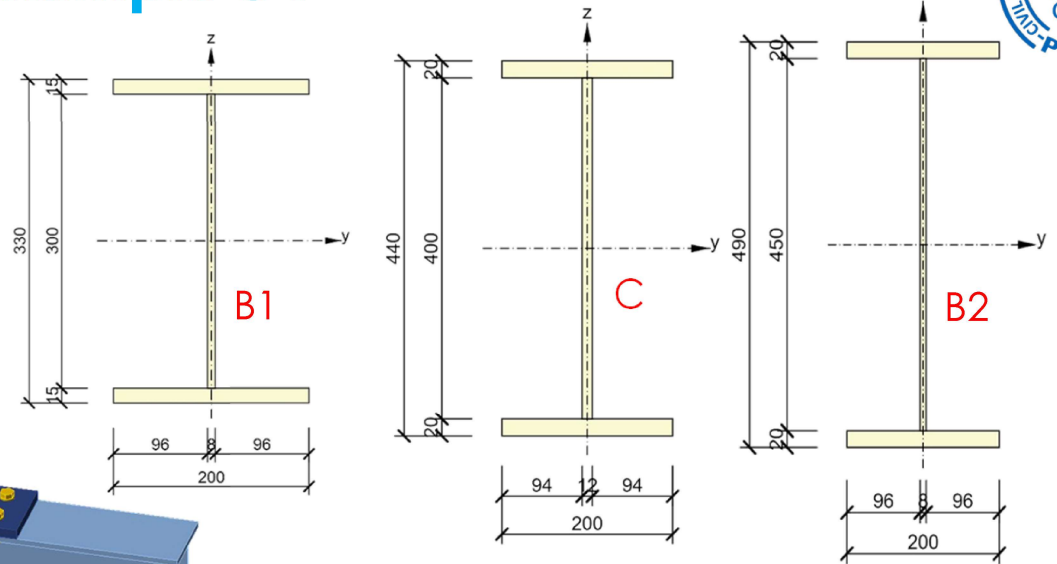
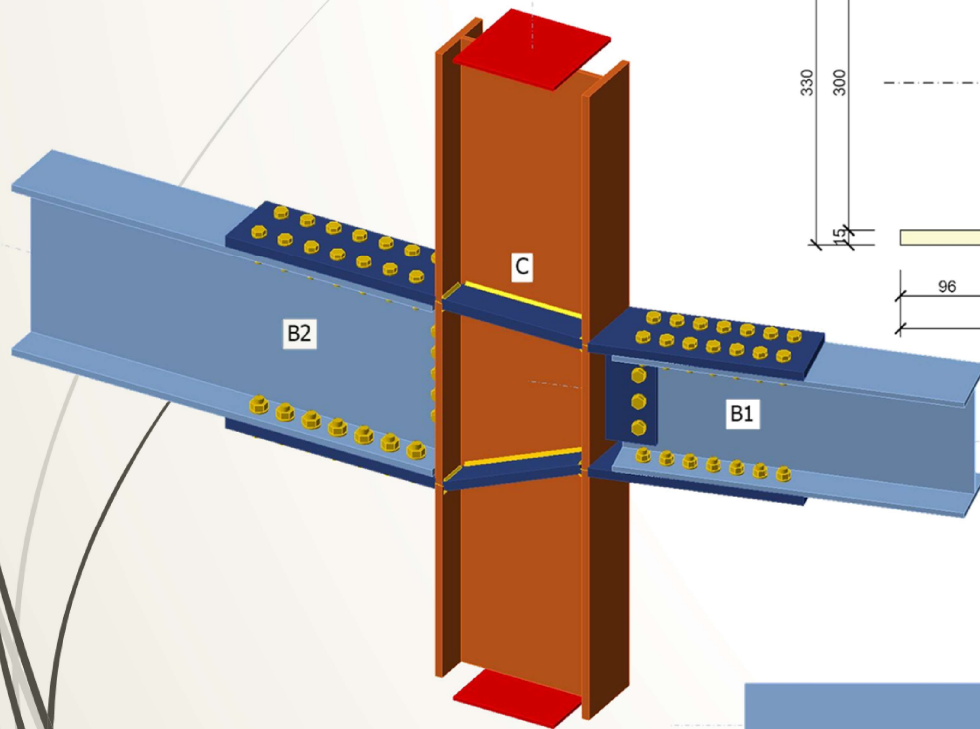
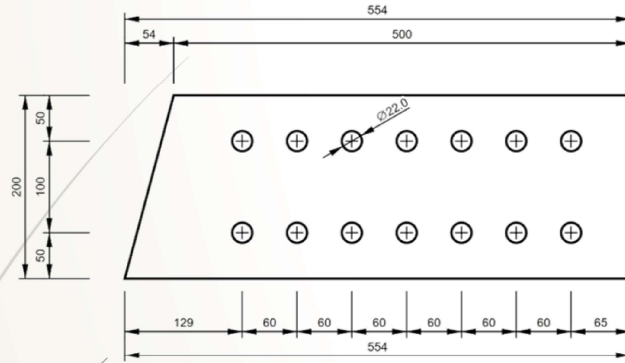

P25.0 / 554 - 200

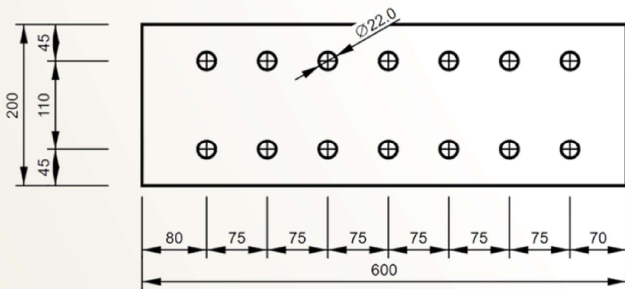

P30.0 / 600 - 200

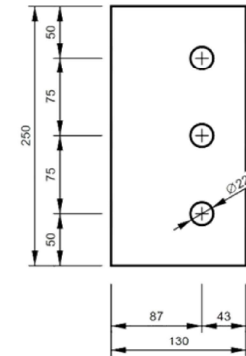

P15.0 / 130 - 250

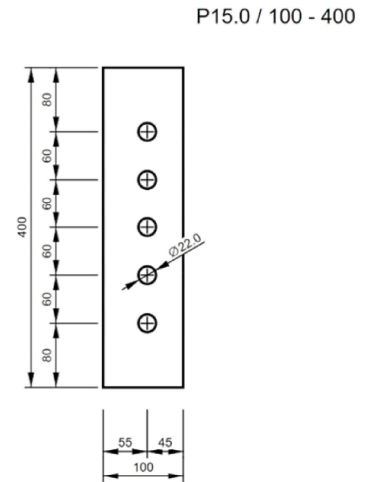

P15.0 / 100 - 400

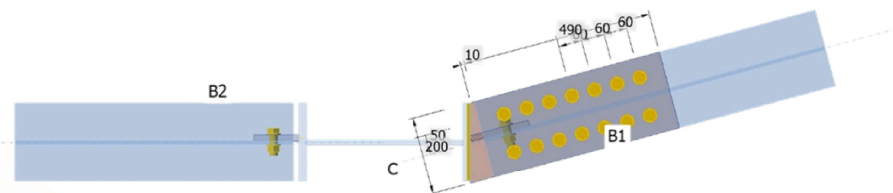

Example 04

3

